

INSTRUCTION BOOK  
FOR  
MODEL LPA-1 LINEAR POWER AMPLIFIER  
AND  
MODEL LPS-1 POWER SUPPLY

**OCT 1960 SRNR 295**

BARKER & WILLIAMSON, INC.  
BRISTOL, PENNSYLVANIA

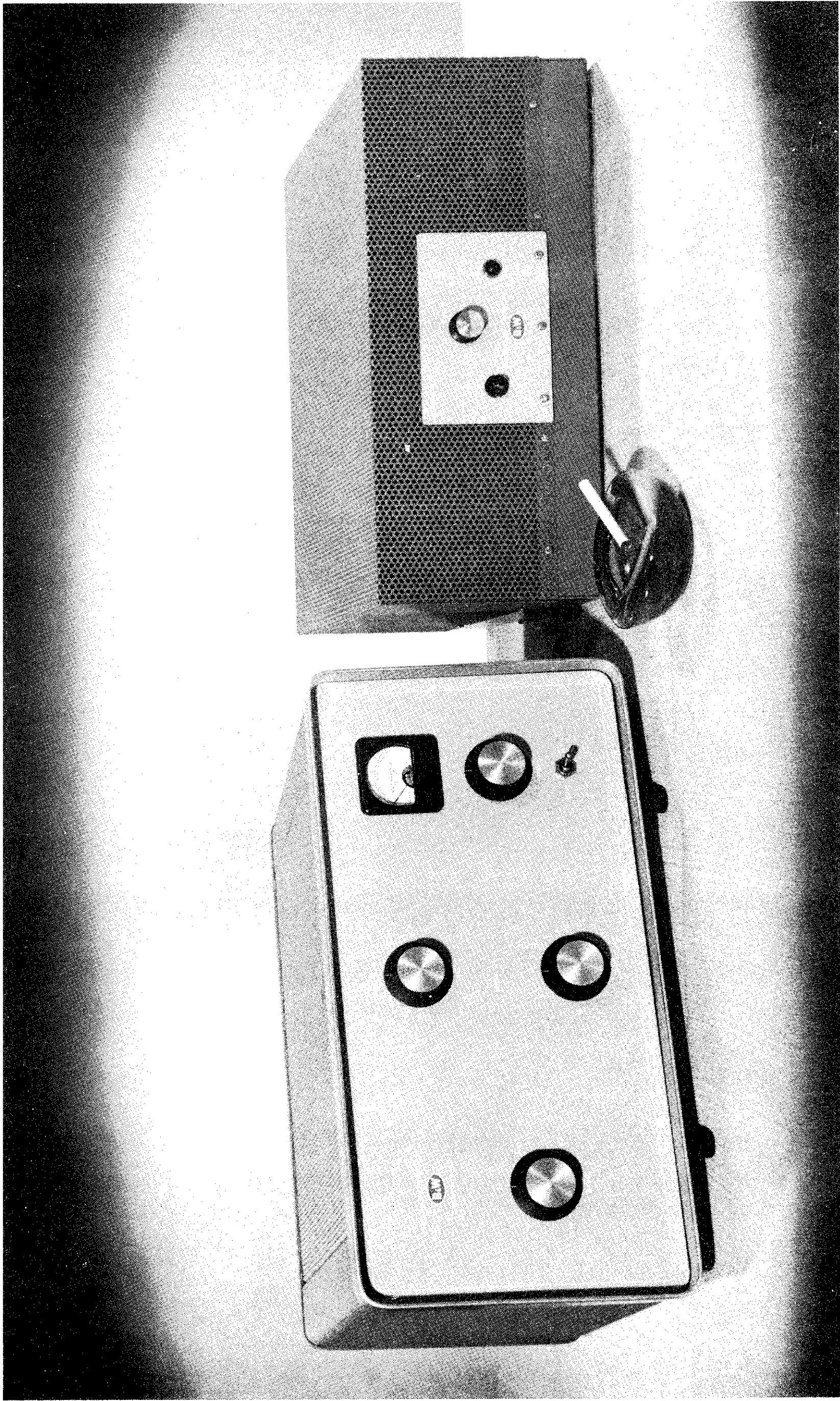

FIGURE 1. MODEL LPA-1 LINEAR POWER AMPLIFIER AND MODEL LPS-1 POWER SUPPLY

## CONTENTS

	<u>Page</u>
Important Warning	i
SECTION 1. Model LPA-1 Linear Power Amplifier	1
SECTION 2. Model LPS-1 Power Supply	9
SECTION 3. Maintenance and Trouble Shooting	11
SECTION 4. Parts Lists	16
Warranty	18

## ILLUSTRATIONS

<u>Figure No.</u>	<u>Title</u>
1	Model LPA-1 Linear Power Amplifier and Model LPS-1 Power Supply
2	Model LPA-1 Linear Power Amplifier, Top of Chassis
3	Model LPS-1 Power Supply, Top of Chassis
4	Model LPS-1 Power Supply, Bottom of Chassis
5A	Connection of LPA-1 to LPS-1
5B	Connections for CW and Linear AM Operation
5C	Connections for SSB, SSB with Carrier and DSB Operation
5D	Bias Connection of LPA-1
6	Schematic Diagram, LPA-1 Linear Power Amplifier
7	Schematic Diagram, LPS-1 Power Supply



### IMPORTANT WARNING

MISUNDERSTANDING OF FUNCTION AND MISUSE OF THIS EQUIPMENT MAY RESULT IN DAMAGE, MALFUNCTION OR BOTH.

THIS EQUIPMENT HAS BEEN FACTORY-TESTED UNDER ACTUAL OPERATING CONDITIONS FOR AN EXTENDED PERIOD ON ALL BANDS, BEFORE IT WAS PLACED IN ITS CARTON. THE TUBES FURNISHED ARE THOSE ACTUALLY USED IN THE OPERATIONAL TEST. THEY WERE ALL UP TO STANDARD PERFORMANCE WHEN PACKED AND SHIPPED FROM THE FACTORY.

OPERATION OF THIS EQUIPMENT IN A MANNER OTHER THAN GIVEN IN STEP-BY-STEP FORM IN THE MANUAL IS AT THE RISK OF THE OWNER. FACTORY WARRANTY ON PARTS, TUBES AND TRANSFORMERS WILL BE VOIDED WHEN THE FACTORY RECOGNIZES THAT EQUIPMENT RETURNED FOR WARRANTY REPAIRS HAS BEEN SUBJECTED TO MISUSE.

HERE ARE A FEW DON'TS THAT EVERY OPERATOR SHOULD OBSERVE:

1. DON'T ATTEMPT TO CONNECT THE AC POWER TERMINALS TO THE POWER LINE, UNLESS YOU ARE THOROUGHLY FAMILIAR WITH THE FUNCTION OF ALL CONTROL KNOBS AND SWITCHES.
2. DON'T TURN POWER ON, UNLESS ALL TUBES ARE IN PROPER SOCKETS AND EQUIPMENT IS CONNECTED TO AN APPROPRIATE ANTENNA FOR THE BAND IN USE OR A NON-INDUCTIVE DUMMY LOAD.
3. DON'T ALLOW THE EQUIPMENT TO OPERATE IN A NON-RESONANT CONDITION - TO DO SO WILL RESULT IN DAMAGED TUBES.
4. DON'T ATTEMPT TO OPERATE THE EQUIPMENT WITH IMPROPER BIAS. SET BIAS IN CONFORMANCE WITH MANUAL INSTRUCTIONS.
5. DON'T USE UNDER-SIZE PRIMARY AC LINE WIRE - USE #14 OR LARGER WIRE FOR CONNECTION TO AC LINE.
6. DON'T DRIVE THE FINAL PLATE MILS ON VOICE PEAKS TO A METER VALUE GREATER THAN 150 TO 180 MA. SEE INSTRUCTION MANUAL UNDER SSB OPERATION.

### SHIPPING DAMAGE

WHERE EQUIPMENT HAS BEEN DAMAGED IN SHIPMENT, AN IMMEDIATE CLAIM SHOULD BE FILED WITH THE CARRIER WHO MADE DELIVERY TO YOUR PREMISES, OR YOUR DISTRIBUTOR.

OUR COMPANY IS NOT RESPONSIBLE FOR SHIPPING DAMAGE.



## Section 1. Model LPA-1 Linear Power Amplifier

Note: It is recommended that the user read, and reread, this instruction book until all connections, controls and functions are clearly understood. You will derive more pleasure from your equipment if you are familiar with its correct operation.

### 1. General

a. The B&W Model LPA-1 Linear Power Amplifier (fig. 1) is designed for desk-top operation. Full legal input power is easily obtained for CW and SSB emission. Linear AM operation is limited to within the dissipation ratings of the power amplifier tubes.

\* 2500Vdc X 400 mA = 1000W

b. The Model LPA-1 Linear Power Amplifier has a self-contained filament and bias supply for the power amplifier tubes. A companion power supply, B&W Model LPS-1 Power Supply, (fig. 1.) was designed to furnish the high voltage, power controls and protection circuits for the most efficient operation of the amplifier, although any well designed and constructed power supply that will furnish the required high voltage and current, may be used.

CAUTION: The metering circuit of the Model LPA-1 Linear Power Amplifier requires that the NEGATIVE POWER SUPPLY LEAD MUST BE INSULATED FROM CHASSIS GROUND.

### WARNING

THE MODEL LPA-1 CHASSIS MUST BE BONDED TO THE MODEL LPS-1 POWER SUPPLY CHASSIS, OR THE POWER SUPPLY CHASSIS IN USE, TO INSURE A GOOD GROUND RETURN PATH BETWEEN THE UNITS.

c. The B&W Model LPA-1 Linear Power Amplifier is shipped in a baffled and padded fibreboard container. The instruction book and two (2) separately wrapped type 813 beam power tubes are included in the container. The user should make sure that the equipment has not been damaged in shipment before making any connections to the unit. If shipping damage is found, notify your distributor at once.

d. B&W Model LPA-1 Linear Power Amplifier has been carefully inspected, tested and adjusted at the factory to assure unlimited, trouble-free operation.

### 2. Installation and Connections

a. Carefully remove the Model LPA-1 Linear Power Amplifier from the fibreboard shipping container and remove all reinforcing pieces.

b. Open the cabinet lid and remove the instruction book and the two (2) type 813 beam power tubes.

\* (1) Measured voltage output tube 355A, operate 3KV

## 2. Installation and Connections (continued)

c. Read the instruction book.

d. Install the two (2) type 813 beam power tubes in their sockets. Connect a plate cap to each tube.

e. Connect the Model LPA-1 amplifier to a power supply (B&W Model LPS-1 Power Supply is recommended) as shown in figure 5A.

### WARNING

DANGEROUS HIGH VOLTAGE IS PRESENT IN ANY POWER SUPPLY. USE EXTREME CARE WHEN MAKING CONNECTIONS AND USING SUCH A SUPPLY. BE SAFE.

f. Turn the power supply switch to the on position (do not apply high voltage to the amplifier yet) and make sure the filaments of the type 813 beam power tubes light and that the blower motor is running.

g. Turn the power supply switch to the TUNE (reduced high voltage) position to check the high voltage supply circuits.

h. Turn off the power supply and observe that the blower motor stops running and that the filaments of the type 813 beam power tubes go off.

i. Locate the Model LPA-1 Linear Power Amplifier as near as possible to the driving transmitter (B&W Model 5100-B with Model 51SB-B recommended) and allow adequate free space on all sides for air circulation and efficient blower operation. Do not place any accessories or equipment on top of the amplifier or transmitter cabinets.

## 3. Antenna Systems

a. The Model LPA-1 Linear Power Amplifier is designed with a nominal 52 or 75 ohm unbalanced output circuit which will feed a variety of antenna systems. Antenna systems of other nominal impedance may be used, however, if they are transformed to 52 or 75 ohms unbalanced at the amplifier termination. Great care should be expended in keeping the VSWR of the antenna feed line as low as possible (1.5:1 or less) because of the high rf voltages present. A well matched, low VSWR feed line will reward the user with greater amplifier efficiency and more power into the antenna.

b. Recommended antenna systems may be found in the instruction book for the B&W Model 5100-B Transmitter, The Radio Amateur's Handbook and the A.R.R.L. Antenna Handbook.

## 4. Controls

a. All operating controls of the Model LPA-1 Linear Power Amplifier are located on the recessed front panel and perform the following functions:



#### 4. Controls (continued)

BAND	Changes taps (inductance) of final tank coil and is mechanically linked to a switch arm on the tank tuning capacitor to select proper capacitance for the band in operation.
10,15,20,40,80	
TUNE	Controls the adjustment of the tank tuning capacitor so that the plate tank circuit may be tuned to resonance (minimum meter reading or dip).
0 through 10	
LOAD	Controls the adjustment of the output loading capacitor for proper loading of the amplifier output.
0 through 10	
BIAS	Controls the output voltage of the bias supply for the proper operating bias voltage applied to the power amplifier tubes.
GRID-PLATE switch	Connects the panel meter into the grid or plate circuit for monitoring drive, plate, loading and bias current of the power amplifier tubes.

#### 5. General Operation

Make all connections to the Model LPA-1 Linear Power Amplifier as shown in the figure for the desired mode of operation. A dummy load, suitable for the frequency and the power output, is recommended while making the initial adjustments to the amplifier. If a dummy load is not available, a well matched antenna may be used.

#### 6. CW Operation (fig. 5B)

a. Make sure that the driving transmitter and the Model LPA-1 Linear Power Amplifier are both adjusted to the same frequency band.

b. Turn on the filament and low voltage to the driving transmitter. Make sure the high voltage is turned off.

c. Place the meter switch of the LPA-1 in the PLATE position and the power supply switch in the ON position. Allow 30 seconds for the tube filaments to warm up.

d. Turn the power supply switch to the OPERATE (full high voltage) position and ~~adjust the LPA-1 BIAS control until the panel meter reads zero (0) plate current.~~ **AND ROTATE BIAS SWITCH TO CW POSITION.**

e. Turn the power supply switch to the ON position and the meter switch of the LPA-1 to the GRID position.

## 6. CW Operation (fig. 5B) (continued)

- f. Apply high voltage to the driving transmitter (filaments and low voltage on) and close the keying circuit.
- g. Tune and load the driving transmitter to obtain a grid current reading of 80 to 90 ma on the LPA-1 panel meter.
- h. Place the meter switch of the LPA-1 in the PLATE position, the LOAD control on zero (0) and adjust the TUNE control for minimum deflection of the panel meter.
- i. Turn power supply switch to the TUNE (reduced high voltage) position and adjust the LPA-1 TUNE and LOAD controls for a reading of 175 ma on the **panel** meter. Each time the LOAD control is adjusted, make sure the TUNE control is adjusted for minimum current reading on the panel meter.
- j. Turn the power supply switch to the OPERATE (full high voltage) position and readjust the TUNE and LOAD controls of the LPA-1 for a reading of 400 ma on the panel meter, using the method described in subparagraph i above. The grid current should be then checked and readjusted to 80 to 90 ma.
- k. Open the keying circuit of the driving transmitter, and the Model LPA-1 is ready for CW operation.

Note: When changing from a dummy load to an antenna system, the Model LPA-1 will usually require slight readjustment of the TUNE and LOAD controls.

## 7. SSB Operation (fig. 5C)

Note: The following instructions are based on using a B&W Model 5100-B Transmitter and a B&W Model 51SB-B Single Sideband Generator to drive the Model LPA-1 Linear Power Amplifier. If other equipment is used to drive the Model LPA-1, these instructions should be modified for the equipment in use.

- a. Refer to paragraph 5 for amplifier load information.
- b. Make sure that the 5100-B transmitter, the 51SB-B sideband generator and the LPA-1 amplifier are all adjusted to the same frequency band.
- c. Turn on the filament and low voltage to the 5100-B transmitter (Model 51SB-B takes its power from Model 5100B). Make sure the high voltage on 5100-B is turned off.
- d. Place the meter switch of the LPA-1 in the PLATE position and the power supply switch in the ON position. Allow 30 seconds for the tube filaments to warm up.



## 7. SSB Operation (continued)

- e. Turn the power supply switch to the OPERATE (full high voltage) position and ~~adjust the LPA-1 BIAS control for a reading of 40 ma on the panel meter.~~ *AND ROTATE BIAS CONTROL SW TO SSB POSITION.*
- f. Turn the power supply switch to the ON position.
- g. Adjust the controls of the 5100-B for CW operation (refer to 5100-B Instruction Manual) and tune and load the transmitter in a normal manner. Keep the 5100-B in operation. Adjust the 5100B for 80 to 90 ma drive to the LPA-1.
- h. Turn the power supply switch to the TUNE (reduced high voltage) position and adjust the LPA-1 TUNE and LOAD controls for a reading of 175 ma on the panel meter. Be sure to readjust the TUNE control for minimum meter reading each time the LOAD control is adjusted.
- i. Turn the power supply switch to the OPERATE (full high voltage) position and readjust the LPA-1 TUNE and LOAD controls for a reading of 400 ma on the panel meter. Again, make sure to adjust the TUNE control for minimum meter reading each time the LOAD control is adjusted until the correct plate current (400 ma) is obtained.
- j. Place the LPA-1 meter switch in the GRID position and observe that the drive from the 5100-B transmitter is between 80 and 90 ma, depending upon the operating frequency.
- k. Place the LPA-1 meter switch in the PLATE position, turn the power supply switch to the ON position and turn off the high voltage to the 5100-B transmitter.
- l. Place the BALANCE-UNBALANCE switch of the Model 51SB-B sideband generator in the UNBALANCE position, the TUNE-OPERATE switch in the TUNE position, the AUDIO GAIN control in the full counterclockwise (off) position and the METER switch in the GRID position.
- m. Turn the 5100-B NORM-SSB switch to the SSB position and turn on the high voltage to the transmitter.
- n. Adjust the 51SB-B DRIVER TUNING and BAL. MOD. TUNING controls for maximum reading on the generator panel meter.
- o. Adjust the 5100-B EXCITATION CONTROL (and the MULTIPLIER TUNING control if necessary) for a reading of 0.5 ma on the 51SB-B panel meter.
- p. Place the 51SB-B BALANCE-UNBALANCE switch in the BALANCE position and the METER switch in the OUTPUT position.
- q. Adjust the two balance controls of the 51SB-B generator until the panel meter reads zero. (When the 51SB-B panel meter reads zero, the carrier is completely balanced out.)

## 7. SSB Operation (continued)

r. Place the 51SB-B TUNE-OPERATE switch in the OPERATE position and the METER switch in the GRID position.

s. Turn the power supply switch to the TUNE (reduced high voltage) position and then to the OPERATE (full high voltage) position.

t. While speaking normally into the microphone, adjust the 51SB-B AUDIO GAIN control until the panel meter on 51SB-B barely kicks upward from zero to not more than two small divisions on the scale, on voice peaks. The PLATE meter on the LPA-1 should not exceed a reading of 150 to 180 ma on voice peaks.

u. The equipments are now properly adjusted for SSB operation.

Note: If a dummy load was used for making the above adjustments, turn off the high voltage on the 5100-B transmitter and turn the power supply switch to the ON position. Disconnect the dummy load and connect the proper antenna to the output connector of the LPA-1 amplifier. Return the 5100-B transmitter to the CW control adjustments and repeat the steps in paragraphs 7 g through s.

## 8. SSB with Carrier Operation (fig. 5C)

Note: The upper or lower sideband may be operated by placing the SIDEBAND, UPPER-LOWER switch of the 51SB-B in the desired sideband position.

a. Refer to paragraph 5 for amplifier load information.

b. Make sure the driving transmitter, sideband generator and the LPA-1 amplifier are adjusted to the same frequency band.

c. Turn on the filament and low voltage to the 5100-B transmitter (Model 51SB-B takes its power from the Model 5100-B). Make sure the high voltage is turned off on the 5100-B transmitter.

d. Place the meter switch of the LPA-1 in the PLATE position and the power supply switch in the ON position. Allow 30 seconds for the tube filaments to warm up.

e. Turn the power supply switch to the OPERATE (full high voltage) position and adjust the LPA-1 BIAS control for a reading of 40 ma on the panel meter.

f. Turn the power supply switch to the ON position and the meter switch of the LPA-1 to the GRID position.



8. SSB with Carrier Operation (continued)

g. Place the BALANCE-UNBALANCE switch of the 51SB-B sideband generator in the UNBALANCE position and the TUNE-OPERATE switch in the TUNE position.

h. Turn on the high voltage of the 5100-B transmitter and tune and load the driving transmitter and sideband generator for a reading of 80-90 ma on the LPA-1 panel meter.

i. Turn the power supply switch to the TUNE (reduced high voltage) position and adjust the TUNE and LOAD controls of the LPA-1 for a reading of 150 ma on the panel meter (see subparagraph 6i).

j. Turn the power supply switch to the OPERATE (full high voltage) position and readjust the TUNE and LOAD controls of the LPA-1 for a reading of 300 ma on the panel meter.

k. Place the BALANCE-UNBALANCE switch of the 51SB-B generator in the BALANCE position and adjust the two balance controls for a zero (o) reading on the 51SB-B panel meter.

l. Readjust either of the two balance controls of the 51SB-B for a reading of 150 ma on the Model LPA-1 panel meter.

m. Adjust the AUDIO GAIN control of the 51SB-B while speaking normally into the microphone until the LPA-1 panel meter **needle** just moves slightly in an upward direction.

CAUTION: Overmodulation with distortion will occur if the LPA-1 panel meter indicates an increase of more than 5% when speaking into the microphone.

9. DSB with Carrier Operation (fig. 58)

a. Repeat the steps in paragraphs 8a through k.

b. Turn off the high voltage to all equipments.

c. Remove the balanced modulator tube V101 from the 51SB-B sideband generator.

d. Turn on the high voltage to all equipments.

e. Readjust the left hand balance control of the 51SB-B for a reading of 150 ma on the LPA-1 panel meter.

f. Repeat the step in paragraph 8m and observe the Caution note.

## 10. Linear AM Operation (fig. 5B)

Note: The B&W Model LPA-1 Linear Power Amplifier can easily be driven to full linear am output power by an am transmitter capable of 25 to 30 watts output. When the B&W Model 5100-B Transmitter or another of similar output is used as the am driving transmitter, the power output must be reduced to 25 to 30 watts.

- a. Refer to paragraph 5 for amplifier load information.
- b. Make sure that the AM driving transmitter and the LPA-1 are adjusted to the same frequency band.
- c. Turn on the filament and low voltage to the driving transmitter. Make sure the high voltage is turned off the driving transmitter.
- d. Place the meter switch of the LPA-1 in the PLATE position and the power supply switch in the ON position. Allow 30 seconds for the tube filaments to warm up.
- e. Turn the power supply switch to the OPERATE (full high voltage) position and adjust the LPA-1 BIAS control ~~for a reading of 40 ma on the panel meter.~~ *to the SSB position*
- f. Turn the power supply to the ON position and the meter switch of the LPA-1 to the GRID position.
- g. Turn on the high voltage to the am driving transmitter (adjusted for am operation) and tune and load for maximum reading on the LPA-1 panel meter.
- h. Place the meter switch of the LPA-1 in the PLATE position and turn the power supply switch to the TUNE (reduced high voltage) position.
- i. Adjust the LPA-1 TUNE and LOAD controls for a reading of 150 ma on the panel meter.
- j. Turn the power supply switch to the OPERATE (full high voltage) position and adjust the AM driving transmitter output for a reading of 300 ma on the LPA-1 panel meter.
- k. Speaking (normally) into the microphone, adjust the AUDIO GAIN control of the driving transmitter to the point where the plate current of the LPA-1 barely changes on voice peaks.

CAUTION: Overmodulation with distortion will occur if the LPA-1 panel meter indicates an increase of more than 5% when speaking into the microphone.



## Section 2. Model LPS-1 Power Supply

### WARNING

DANGEROUS HIGH VOLTAGE IS PRESENT

WHEN THIS POWER SUPPLY IS TURNED ON

CAUTION: Do not turn this power supply on without a suitable load being connected to the output terminals.

### 11. General

a. The B&W Model LPS-1 Power Supply (figs. 3 & 4) is designed to be used with the B&W Model LPA-1 Linear Power Amplifier. It may be placed at the operating position or located remotely and controlled from the operating position by means of the removable front panel which contains the control switching, protective fuse circuit and the high voltage indicating light.

b. A separate panel is supplied for use when the Model LPS-1 is remotely located. A control cable is furnished for connection to the Model LPA-1 Linear Power Amplifier when the two equipments are placed side by side.

c. The power supply is shipped in a baffled and padded fibreboard container. The remote panel, voltage reducing resistor, control cable and power cord are included in the container. The user should make sure that the equipment has not been damaged in shipment before making any connections to the unit. If shipping damage is found, notify your distributor at once.

d. The Model LPS-1 Power Supply has been carefully inspected and tested at the factory to assure unlimited, trouble-free operation.

### 12. Installation and Connections

a. Carefully remove the LPS-1 Power Supply from the fibreboard shipping container.

b. Carefully lift off the cover and remove all reinforcing pieces. Remove the remote panel, voltage reducing resistor, control cable, power cord and envelope containing hardware.

c. Install the voltage reducing resistor in the standard screw type ac socket.

d. Remove the fuse and inspect it to make sure it is good.

Note: Do not use a fuse rated higher than 15A, 125V.

e. Connect a suitable load on the Model LPA-1 Linear Power Amplifier to the output terminals as shown in figure 5B.

## 12. Installation and Connections (continued)

f. Connect the LPS-1 to the LPA-1 as shown in figure 5A.

g. Install the power cord and connect to a 115-volt, 60 cycle supply source and turn the switch to the ON position.

Note: New mercury type tubes (such as type 816) should be operated with filament voltage ONLY for a half-hour when they are first put into service.

h. After operating the type 816 tubes on filament voltage for one-half hour, turn the switch to the TUNE position and then to the OPERATE position to check the high voltage circuits.

i. Replace the perforated cover and secure it with the twelve (12) screws provided.

## 13. Remote Location of Power Supply

a. Carefully remove the perforated cover.

b. Provide wires long enough to reach between the control panel and the remote power supply location. Use #14 AWG or larger wire for all primary (115 v, 60 cycle) leads. The high voltage indicating pilot light may be connected with #18 AWG or larger size wire. Lace or tape these wires together to form a cable.

c. Slip the remote cable through the grommet hole in the remote panel and proceed to connect one wire at a time between the control panel and the terminal board located behind the control panel. Use of color coded wire will simplify identification of leads.

d. Remove the control panel and locate it at the operating position. Fasten the remote panel to the Model LPS-1 chassis with the flat washers (provided) between the panel and the chassis.

e. Check the operation (connect load) of the Model LPS-1 and, if all connections are correct, replace the perforated cover. The Model LPS-1 may now be controlled from the operating position.



### Section 3. Maintenance and Trouble Shooting

#### 14. Maintenance

a. The B&W Model LPA-1 is designed to require a minimum of servicing. In most cases, faulty operation is caused by weak or defective tubes. To minimize the need for repairs and to assure uninterrupted operation of the equipment, it is recommended that the following procedures be followed twice a year, and more frequently if the equipment is used for long periods daily.

#### WARNING

MAKE SURE THAT ALL POWER LEADS ARE DISCONNECTED FROM THE MODEL LPA-1 BEFORE ANY MAINTENANCE WORK IS ATTEMPTED. BE SAFE!

- (1) Remove the type 813 tubes from their sockets and inspect the pins for signs of heating caused by defective socket contact. Removing and replacing the tubes in their sockets cleans the tube pins and socket contacts. Clean bulbs and bases and reinstall.
- (2) Carefully clean tank coil, both variable capacitors and all chassis surfaces with a soft brush. If dirt or dust sticks to the chassis or components, use a small amount of carbon-tetrachloride.
- (3) Apply three or four drops of light machine oil in each of the two oiling tubes of the blower motor. Make sure the blower rotates freely.
- (4) Apply a small amount of "Lubriplate" around ball detent holes of the tank coil and the mechanical link arms of the coil and tuning capacitor.
- (5) Inspect all screws, nuts, components and wire connections, making sure they are tight and in good condition.

b. To remove the Model LPA-1 Linear Power Amplifier from its case, proceed as follows:

- (1) Remove the screws from the four feet on the bottom of the large chassis. The short feet are located at the rear and the longer feet are located at the front.
- (2) Lift the cabinet lid and remove the two screws from the weld studs located along the top inside edge of the front panel.
- (3) Remove the three screws located along the rear edge and the three screws located along the front edge on the bottom of the cabinet.

#### 14. Maintenance (continued)

- (4) Carefully slide the amplifier from its case.
- (5) To reassemble, reverse the above steps, being careful not to damage any parts.

c. To remove the tube chassis from the main chassis, first remove the main chassis from the case and proceed as follows:

- (1) Remove the plate caps from the type 813 tubes.
- (2) Disconnect the blower plug from the tube chassis receptacle.
- (3) Remove the BIAS control knob.
- (4) Remove the two nuts from the meter terminals and remove the resistor assembly board from the meter.
- (5) Remove the BIAS control potentiometer from the front panel.
- (6) Remove the meter switch from the front panel (keep the switch terminals toward the top of the panel when reassembling so meter will read correct GRID or PLATE current).
- (7) Remove the large (1/4 x 20) screw in the top of the plate choke.
- (8) Hold the tube chassis. Remove the seven screws which secure the tube chassis to the main chassis.
- (9) To reassemble, reverse the above steps, being careful not to damage any of the components.

#### 15. Trouble Shooting and Repair

The following chart lists the common causes of trouble. It is not intended to be all inclusive but to serve only as a guide in helping to locate the trouble. Refer to the schematic diagrams, figures 6 and 7 for the Model LPA-1 and LPS-1 respectively.

##### WARNING

DANGEROUS HIGH VOLTAGE IS PRESENT IN ANY  
POWER SUPPLY OR EQUIPMENT THAT IS TURNED ON.  
USE EXTREME CARE WHEN TROUBLE SHOOTING EQUIPMENT  
UNDER POWER ON CONDITIONS.

CAUTION: Do not use a fuse rated at more than 15 amperes  
in the power supply.



15. Trouble Shooting and Repair (continued)

Symptom	Check	Cause and Remedy
<p>Completely inoperative Model LPA-1.</p>	<p>115 v, 60 cycle input voltage</p> <p>Fuse F101</p> <p>Type 813 tubes</p> <p>Transformers T101, T201</p>	<p>No voltage. Replace primary fuse. Repair or connect primary power mains.</p> <p>Blown fuse F101. Replace. <u>USE ONLY A 15A, 125V FUSE.</u></p> <p>Shorted tube filament. Replace tube (or tubes).</p> <p>Shorted transformer T101 or T201. Replace.</p>
<p>Panel meter reads off scale Fuse blows.</p>	<p>Fuse F101</p> <p>Type 813 tubes</p> <p>Capacitors C205 through C209</p>	<p>Wrong value fuse F101. Replace. <u>USE ONLY A 15A, 125V FUSE.</u></p> <p>Tube glows blue. Replace.</p> <p>Shorted or leaky capacitor C205 through C209. Replace.</p>
<p>Fuse blows. Panel meter reads normal.</p>	<p>Fuse F101</p> <p>Type 813 tubes</p> <p>Transformers T101, T102</p> <p>Capacitors C101 through C108</p> <p>Resistors R101 through R108</p>	<p>Wrong value fuse F101. Replace. <u>USE ONLY A 15A, 125V FUSE.</u></p> <p>Defective tube. Replace.</p> <p>Shorted transformer T101 or T102. Replace.</p> <p>Faulty capacitor C101 through C108. Replace.</p> <p>Defective resistor R101 through R108. Replace.</p>
<p>-13-</p>		

Section 4. Parts Lists (continued)

Model LPS-1 Power Supply

<u>Symbol</u>	<u>Description</u>	<u>B&amp;W Number</u>
C101 thru C108	Capacitor, electrolytic, 80 mf, 400 v	4553-1
C109	Capacitor, paper, .1 mf, 3 kv	4507-63
C110	Capacitor, ceramic, .001 mf, 5 kv	4552-1
C111, C112	Capacitor, feed-thru, ac line	4507-62
C113	Capacitor, disk, .01 mf, 600 v	4525-21
L101	Choke, filter	51204
L102 thru L104	Choke, rf	50359
L105	Choke, rf, 1 mh, 400 ma	X-371
R101 thru R108	Resistor, wirewound, 20 K ohms, 20 w	4431-12
R109	Resistor, cone heater type, 1000 w, 115 v	51405
R110	Resistor, composition, 100 K ohms, 1/2 w	4401-104K
SW101	Switch, power	51404
T101	Transformer, plate	51481
T102	Transformer, filament	51480
F101	Fuse, 15 amp, 125 v	5201-7
PL101	Lamp, bayonet type, 6.3 v, 300 ma	4716-16
V101 thru V104	Tube, type 816	816
	Cable assembly	51493
	AC power cord	51259



15. Trouble Shooting and Repair (continued)

Symptom	Check	Cause and Remedy
<p>No grid drive.</p>	<p>Capacitors C202, C203, C204</p> <p>Variable resistor R202</p> <p>RF choke L201</p>	<p>Open or shorted capacitors C202, C203, C204. Replace.</p> <p>Defective variable resistor R202. Replace.</p> <p>Open or shorted rf choke L201. Replace.</p>
<p>Excessive drop in grid drive when high voltage is applied.</p> <p>Note: Normal grid drop for SSB operation is approximately 25%.</p> <p>No plate current.</p>	<p>Type 813 tubes</p> <p>Filter choke L101</p> <p>Plate choke L202</p> <p>RF choke L203</p>	<p>Low filament emission of type 813 tube (tubes). Replace.</p> <p>Open filter choke L101. Replace.</p> <p>Open plate choke L202. Replace.</p> <p>Open rf choke L203. Replace.</p>
<p>Arc-over in variable capacitor.</p>	<p>Variable capacitors C210, C211</p> <p>Rf choke L205</p> <p>Antenna system</p>	<p>Dirt or other material between capacitor plates. Clean.</p> <p>Open or shorted rf choke L205. Replace.</p> <p>High VSWR condition or a defect in the antenna system. Adjust for a VSWR of 1.5:1 or less. Repair fault.</p>

15. Trouble Shooting and Repair (continued)

Symptom	Check	Cause and Remedy
Will not tune when adjusted to same band as driving transmitter.	Mechanical linkage between coil L204 and capacitor C210	Defective adjustment in mechanical linkage between tank coil L204 and variable capacitor C210. Adjust so the switch arm on capacitor C210 shorts both the front and rear sections when coil L204 is adjusted to both 40 and 80 meters. When coil L204 is adjusted to 10, 15 or 20 meters the capacitor C210 switch arm should be open.



Section 4. Parts Lists

Model LPA-1 Linear Power Amplifier

<u>Symbol</u>	<u>Description</u>	<u>B&amp;W Number</u>
C201, C202, C212, C213, C215, C216	Capacitor, disk, .01 mf, 600 v	4525-21
C204	Capacitor, disk, .001 mf, 500 v	4525-20
C205 thru C209	Capacitor, ceramic, .001 mf, 5 kv	4552-1
C210	Capacitor, variable, air	51242
C211	Capacitor, variable, air	51241
C214	Capacitor, electrolytic, 40-40 mf, 150 v	4553-6
CR201	Rectifier, selenium, 130 v, 65 ma	51253
L201	Choke, rf, 500 uh, 100 ma	50711
L202	Choke, rf, plate	X-368
L203, L205	Choke, rf, 1 mh, 400 ma	X-371
L204	Coil, pi-network	Model 850A
R201	Resistor, wirewound, 500 ohms, 5 w	4431-8
R202	Resistor, variable, 500 ohms, <sup>25</sup> / <sub>2</sub> w	4419-14
R203, R204	Resistor, shunt, 5 ohms ±1%, <sup>2</sup> / <sub>2</sub> w	4409-27
R205	Resistor, series, 2445 ohms ±1%, 1/2 w	4425-56
M201	Meter, 0-500 ma DC scale	5103-1
SW201	Switch, toggle, SPDT	4600-5
SW202	" ROTARY 1 POLE	51585
B201	Blower, 115 v AC, 60 cycle	51255
SW203	SWITCH, INTERLOCK 15A, 230V	4605
T201	Transformer, filament	51206
T202	Choke, filament	51477
J201	Receptacle, rf	5085
J202	Receptacle and cable assembly	51401
V201, V202	Tube, type 813	813

Note: Beam Power tubes of the 813 type, when new or after prolonged storage, will occasionally flash over when plate voltage is first applied. This is due to residual gas in the tube which is eliminated by the flashover. This condition will not recur during normal operation.

STANDARD WARRANTY

Adopted and Recommended by the  
Radio-Electronics-Television Manufacturers Association

Barker & Williamson, Inc. warrants each new radio product manufactured by it to be free from defective material and workmanship and agrees to remedy any such defect or to furnish a new part in exchange for any part of any unit of its manufacture which under NORMAL INSTALLATION, USE and SERVICE discloses such defects, provided the unit is delivered by the owner, to our authorized dealer or wholesaler, from whom purchased, intact, for their examination, with all transportation charges prepaid. This warranty is valid, only within 90 days from the date of purchase and is limited to new equipments.

This warranty does not extend to any of our radio products which have been subjected to MISUSE, NEGLECT, ACCIDENT, INCORRECT WIRING NOT OUR OWN, IMPROPER INSTALLATION, OR TO USE IN VIOLATION OF INSTRUCTIONS FURNISHED BY US, NOR EXTEND TO UNITS WHICH HAVE BEEN REPAIRED OR ALTERED OUTSIDE OF OUR FACTORY, NOR IN CASES WHERE THE SERIAL NUMBER THEREOF HAS BEEN REMOVED, DEFACED OR CHANGED, NOR TO ACCESSORIES USED THEREWITH NOT OF OUR OWN MANUFACTURE.

This warranty is in lieu of all other warranties expressed or implied and no representative or person is authorized to assume for us any other liability in connection with the sale of our radio products.



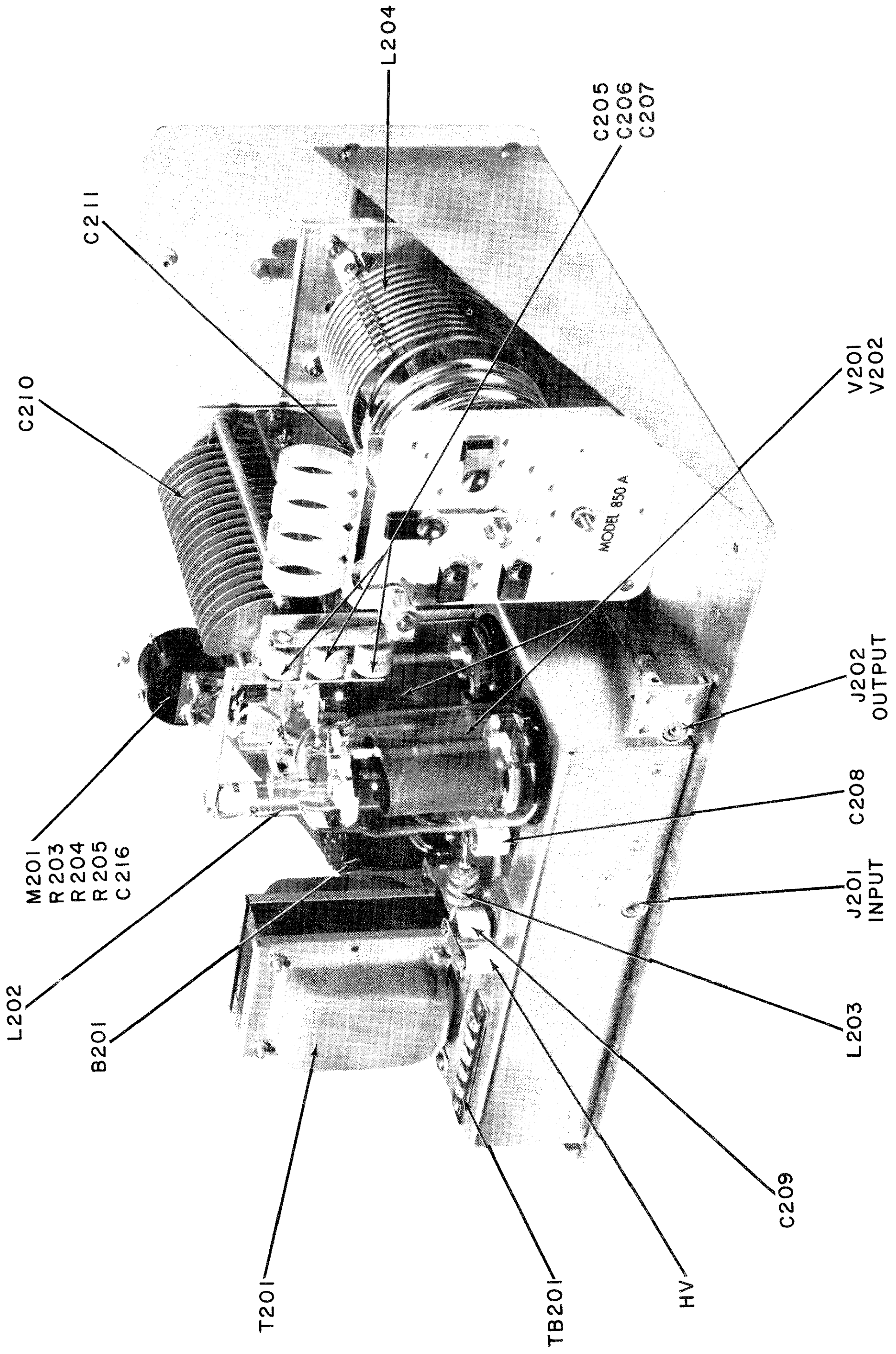

FIGURE 2. MODEL LPA-1 LINEAR POWER AMPLIFIER, TOP OF CHASSIS

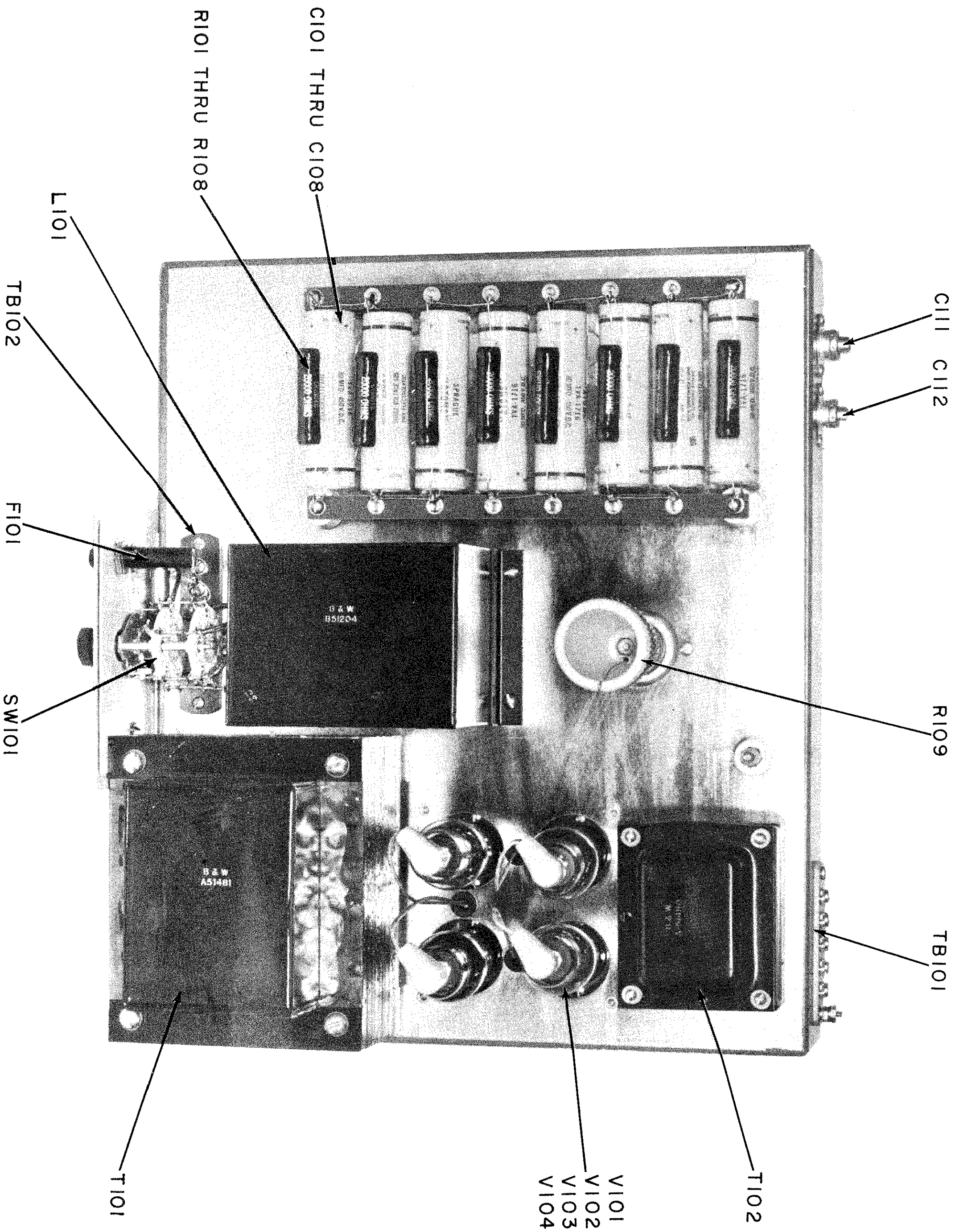

FIGURE 3. MODEL LPS-1 POWER SUPPLY, TOP OF CHASSIS



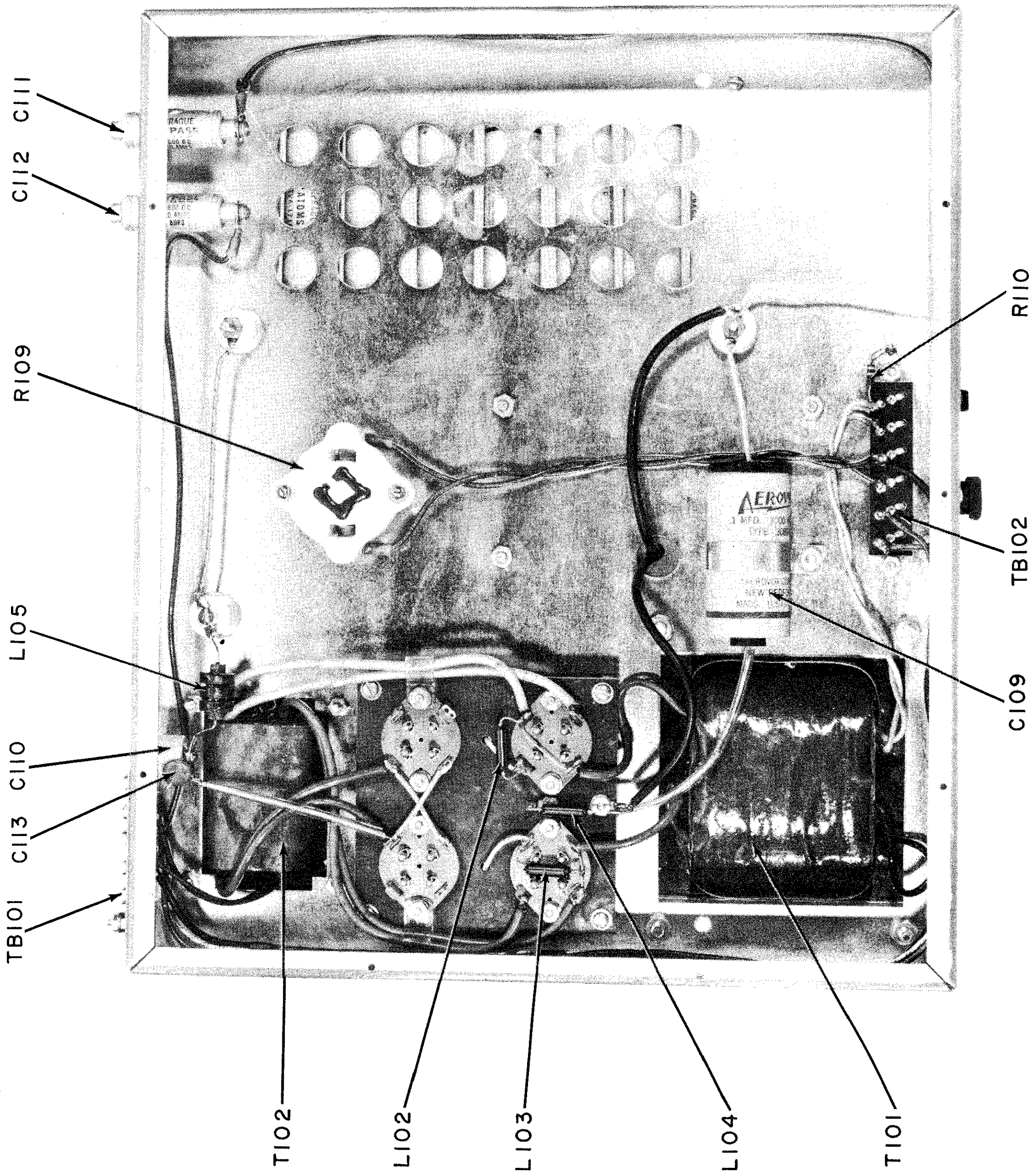
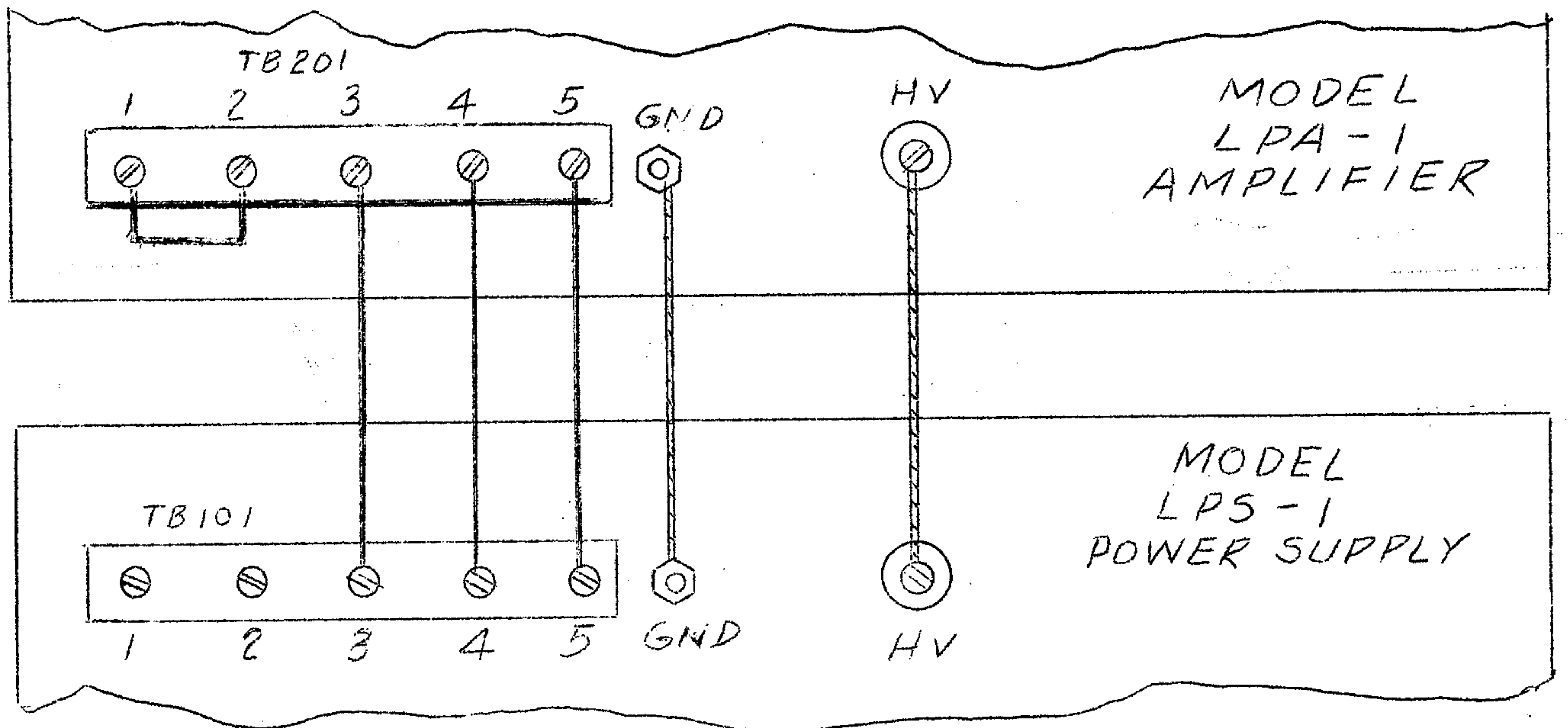
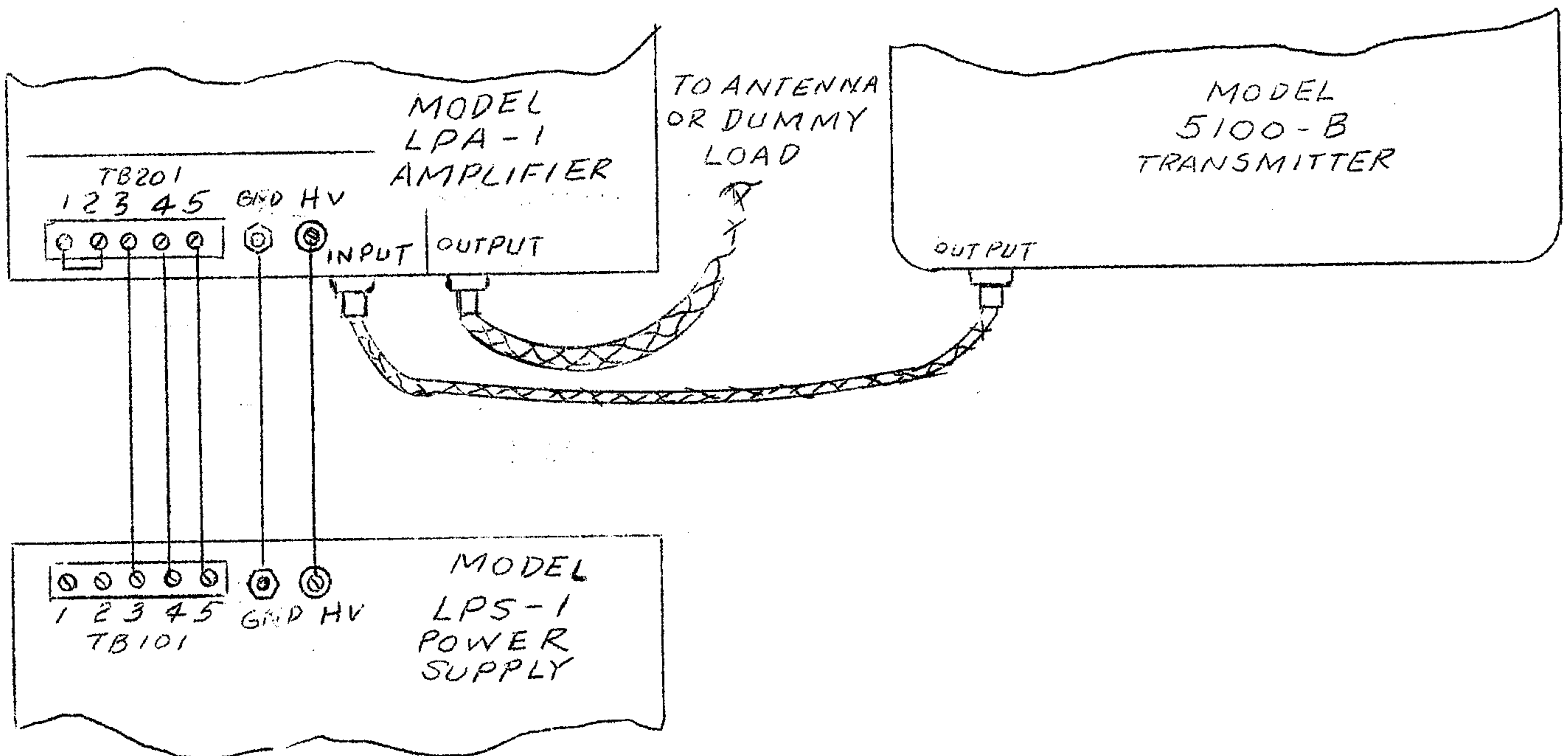

FIGURE 4. MODEL LPS-I POWER SUPPLY, BOTTOM OF CHASSIS



NOTE: CONNECT A LOAD TO LPA-1 AND THE AC LINE TO THE LPS-1  
 FIGURE 5A. CONNECTION OF LPA-1 TO LPS-1



NOTE: CONNECT A LOAD TO THE LPA-1 AND THE AC LINE TO THE LPS-1.  
 FOR TERMINAL CONNECTIONS ON THE 5100-B TRANSMITTER, REFER TO THE INSTRUCTION BOOK

CONNECTIONS FOR CW AND LINEAR AM OPERATION

FIGURE 5B



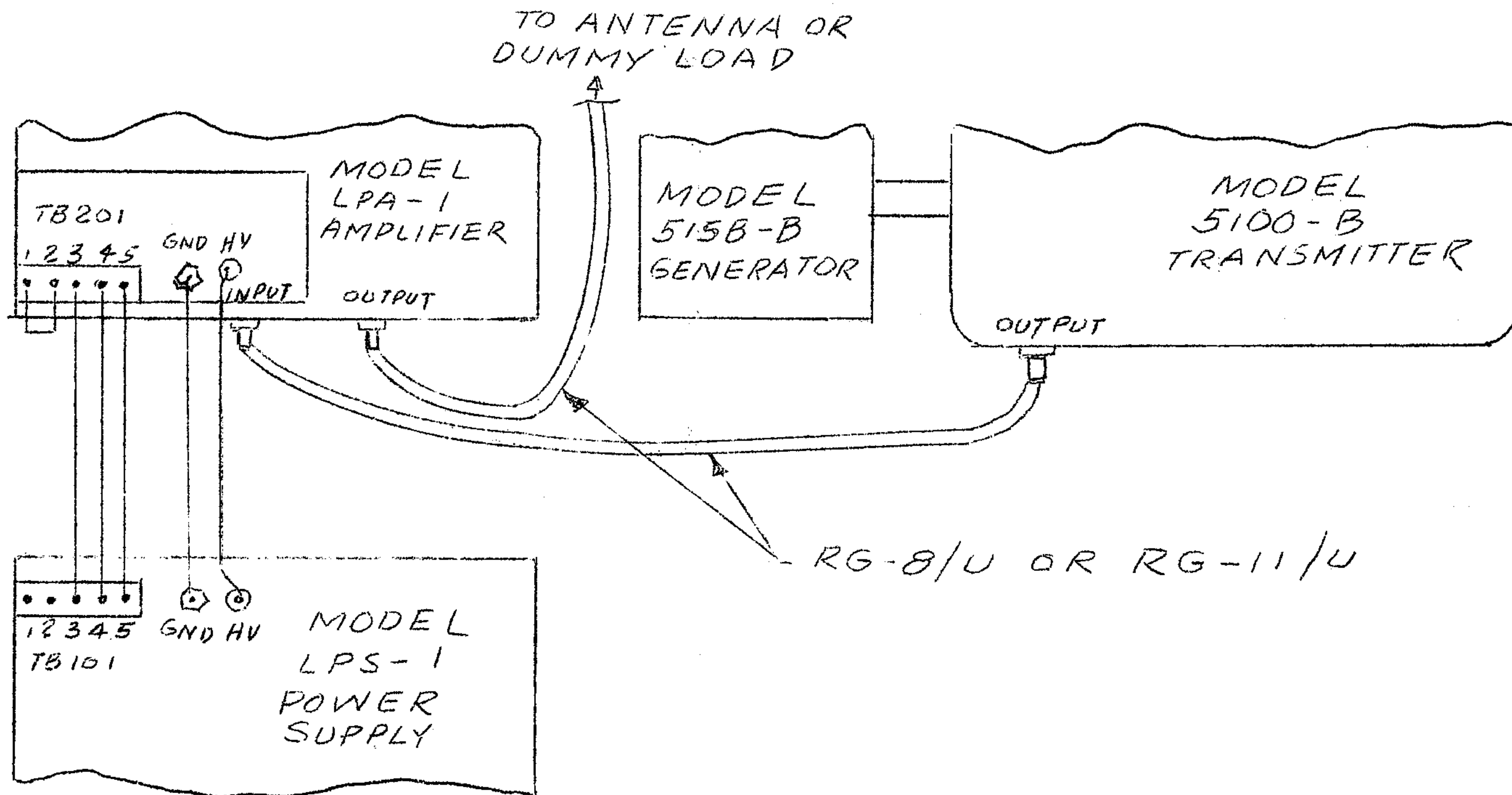

NOTE: CONNECT A LOAD TO THE LPA-1 AND THE AC LINE TO THE LPS-1.  
 FOR CONNECTIONS ON THE 515B-B AND 5100-B TRANSMITTER, REFER TO THE INSTRUCTION BOOK

CONNECTION FOR SSB, SSB WITH CARRIER AND DSB OPERATION  
 FIGURE 5C

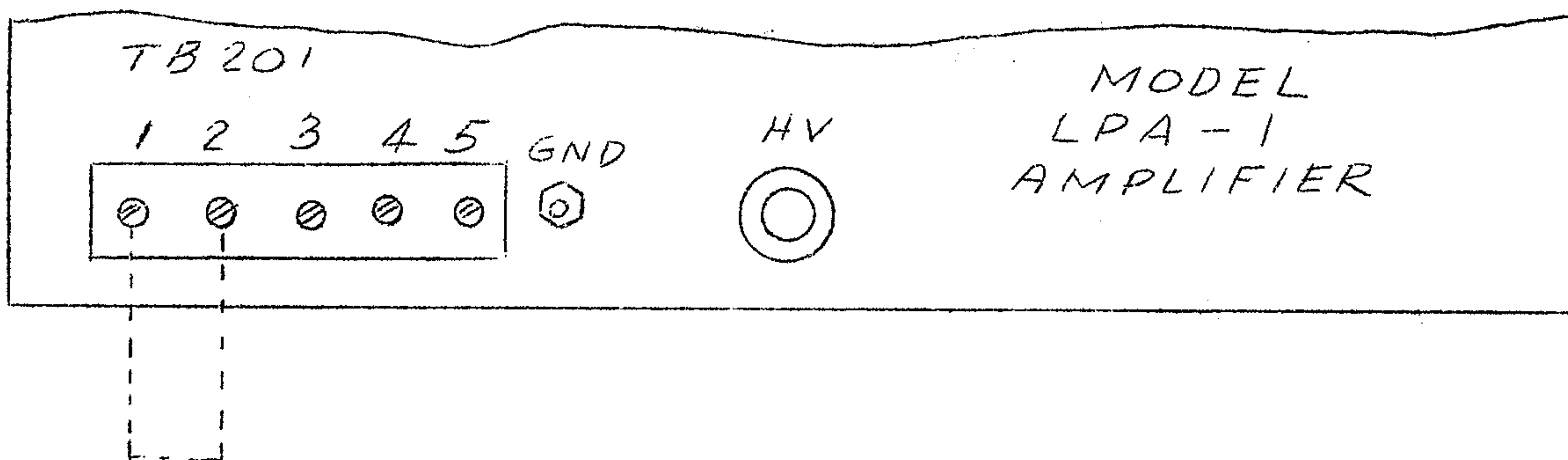

NOTE! TERMINALS 1 AND 2 ARE NORMALLY CONNECTED TOGETHER.  
 FOR BREAK-IN OPERATION REMOVE THE JUMPER AND CONNECT TERMINALS 1 AND 2 TO A PAIR OF NORMALLY OPEN CONTACTS OF THE VOICE ACTUATED RELAY IN THE DRIVING TRANSMITTER.

BIAS CONNECTION OF LPA-1  
 FIGURE 5D.

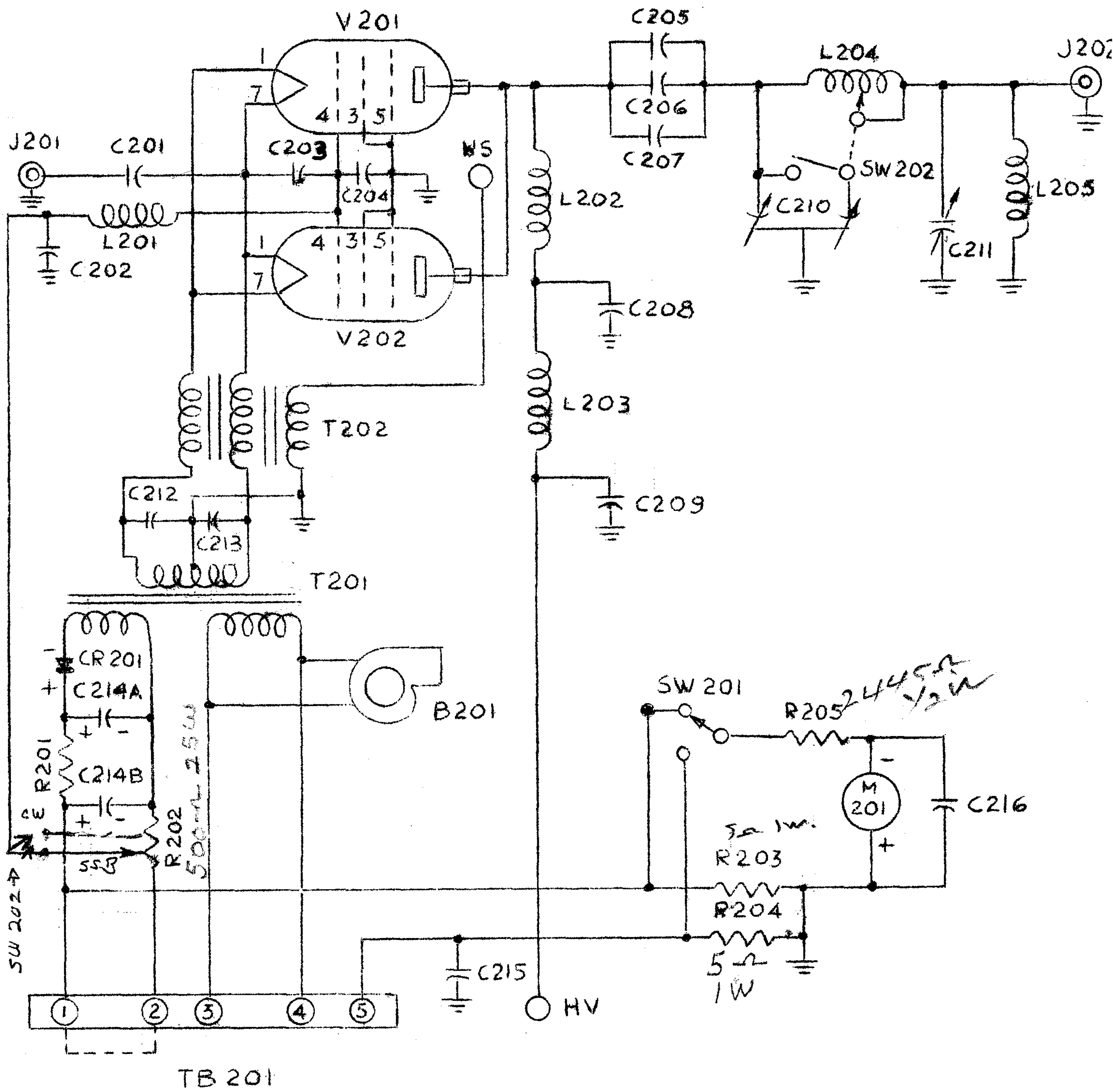

MODEL LPA-1  
 LINEAR AMPLIFIER  
 SCHEMATIC DIAGRAM

FIGURE 6.



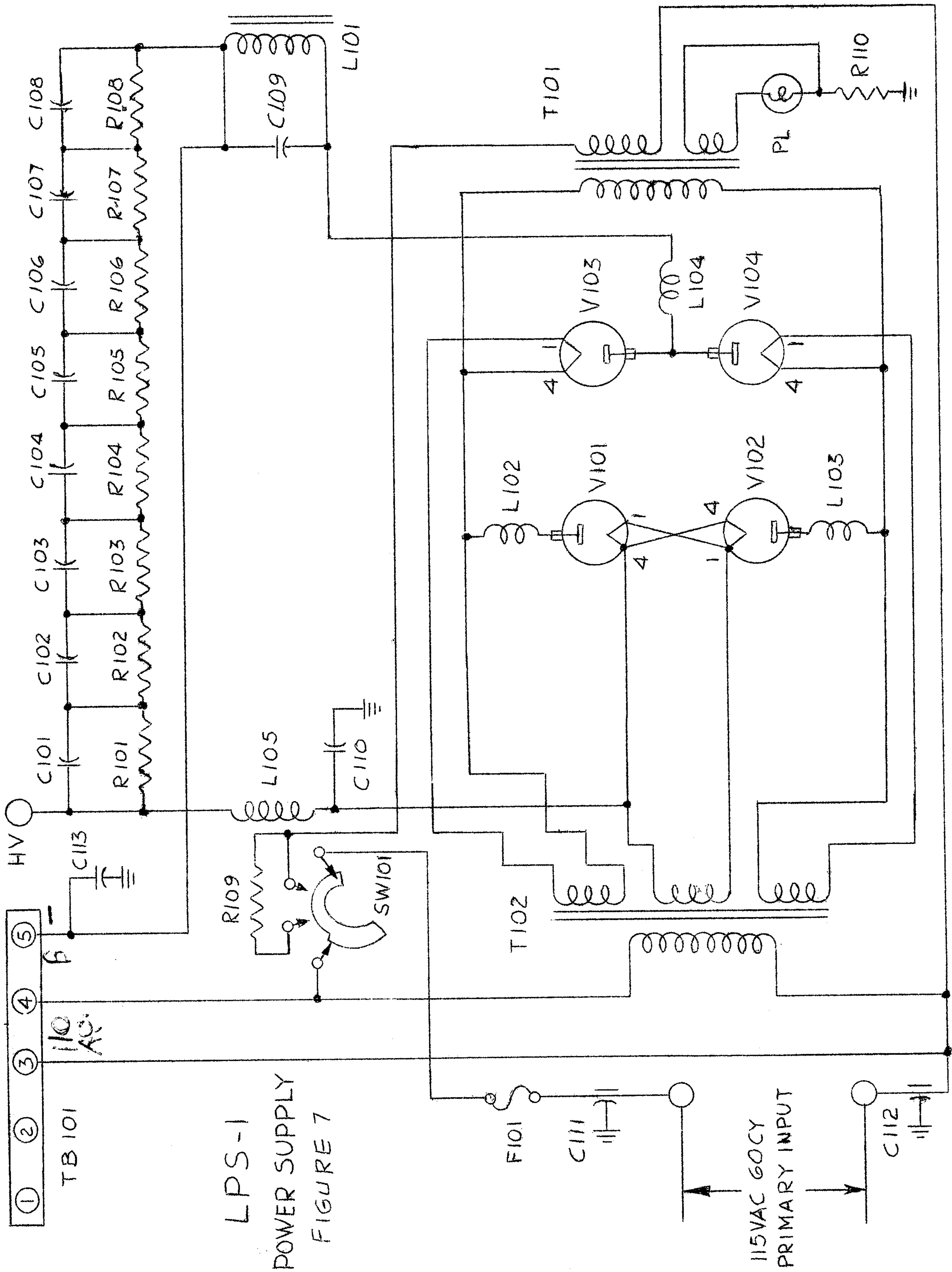

## ADDENDUM #1

### LPA-1 Amplifier - LPS-1 Power Supply

Certain design changes have been incorporated in the LPA-1, serial No.251 and above, and all LPS-1 power supplies shipped from the factory after Nov. 1, 1960. These changes will improve operating features, increase reliability and provide the ultimate in operator safety.

#### AMPLIFIER

Bias control R202 has been replaced with an adjustable 500 ohm, 25 watt, wire-wound resistor and a single pole 2 position rotary switch SW202. These components are arranged such that correct operating static plate current is established for all modes of operation, by simply rotating the switch to the desired operating mode.

Meter shunt resistor R204 has been changed from a 1 watt to a 2 watt rating. The resistance value (5.0 ohms) is unchanged.

A positive acting interlock switch has been added, which removes primary voltage from plate transformer T101 when the lid of the cabinet is lifted a slight amount. A B+ grounding assembly has been added to the amplifier, which functions to ground the B+ terminal of the power supply, after the lid is lifted sufficiently to open the interlock switch.

#### POWER SUPPLY

The voltage rating of capacitor C109 has been increased from 3000 to 4000 volts.

Circuit changes in the LPA-1 amplifier and LPS-1 power supply are shown on sheet (3).

Reference should be made to these changes when trouble-shooting or repairing this equipment. The changes are relatively simple and will be easily understood by comparing the partial schematics to the basic schematic.

The following changes should be made in the operating instruction text.

Page 3, par. 6d (CW operation)

Delete par. 6d in its entirety and substitute the following:

- 6d. Turn the power supply switch to the OPERATE position (full high voltage) and rotate the BIAS control to the CW position.

✓ Page 5, par. 7e (SSB operation)

Delete par. 7e in its entirety and substitute the following:

- 7e. Turn the power supply switch to the OPERATE position (full high voltage) and rotate the BIAS control to the SSB position.

Page 6, par. 8e (SSB with carrier operation)

Delete par. 8e in its entirety and substitute the following:

- 8e. Turn the power supply switch to the OPERATE position (full high voltage) and rotate the BIAS control to the SSB position.



Page 8, par. 10e (Linear AM operation)

Delete par. 10e in its entirety and substitute the following:

- 10e. Turn the power supply switch to the OPERATE position (full high voltage) and rotate the BIAS control to the SSB position.

Make the following changes in the parts list for LPA-1 Linear Power Amplifier (page 16)

Change description and part No. of R202 to read

- ✓ Resistor, adjustable, 500 ohms  
25 watts. B & W No.4426-7

Change description and part No. of R204 to read

- ✓ Resistor, shunt, 5 ohms  $\pm$  1%,  
2 watts. B & W part No.4409-36

Add the following symbols descriptions and part nos.

- ✓ SW202, switch, rotary. 1 pole  
2 position, B & W part No.51585
- ✓ SW203, switch, interlock, 15 amp  
230V. B & W part No.4605

Make the following changes in the parts list for LPS-1 Power Supply (Page 17)

Change description and part No. of C109 to read.

- Capacitor, paper. .1 MFD, 4 KV  
B & W part No.4507-93

Bias Adjustment

MODE BIAS CURRENT  
CW = 19VDC = 0 MA  
SSB = 5VDC 40MA

Ordinarily, the position of the two taps on bias resistor R202 is set at the factory to provide the correct static plate current of 40 ma in the SSB position and 0 ma in the CW position, with the equipment operating with 115VAC 60 cycles.

If the static plate current departs more than  $\pm$  5 ma from the correct values indicated above, due to line voltage extremes, it will be necessary to readjust the taps on the bias resistor. This may be done as follows.

Bias resistor R202 is located on the right side of the chassis and adjacent to the BIAS switch. The position of the sliding tap on R202 nearest the front panel sets the static plate current for the CW position, while the other tap sets the static plate current for the SSB position.

Apply AC power not plate voltage to the amplifier. Connect the plus lead of an accurate DC voltmeter to chassis ground. Connect the remaining lead to the CW tap on R202. Position the tap for a reading of minus 19.0 volts. Tighten the screw in the slider and connect the negative lead of the voltmeter to the SSB tap. Position this tap for a reading of minus 5.0 volts. Tighten screw in the slider, remove test leads and close lid of LPA-1 cabinet.

With excitation removed from the amplifier, apply full plate voltage. Turn BIAS switch to the CW position and throw meter switch to PLATE. The IPA-1 meter should read 0 MA. Turn Bias switch to SSB. The meter should read 40 ma  $\pm$  4 ma.

This completes the adjustment of bias resistor R202.

(2)

INTER-LOCK SWITCH WIRING

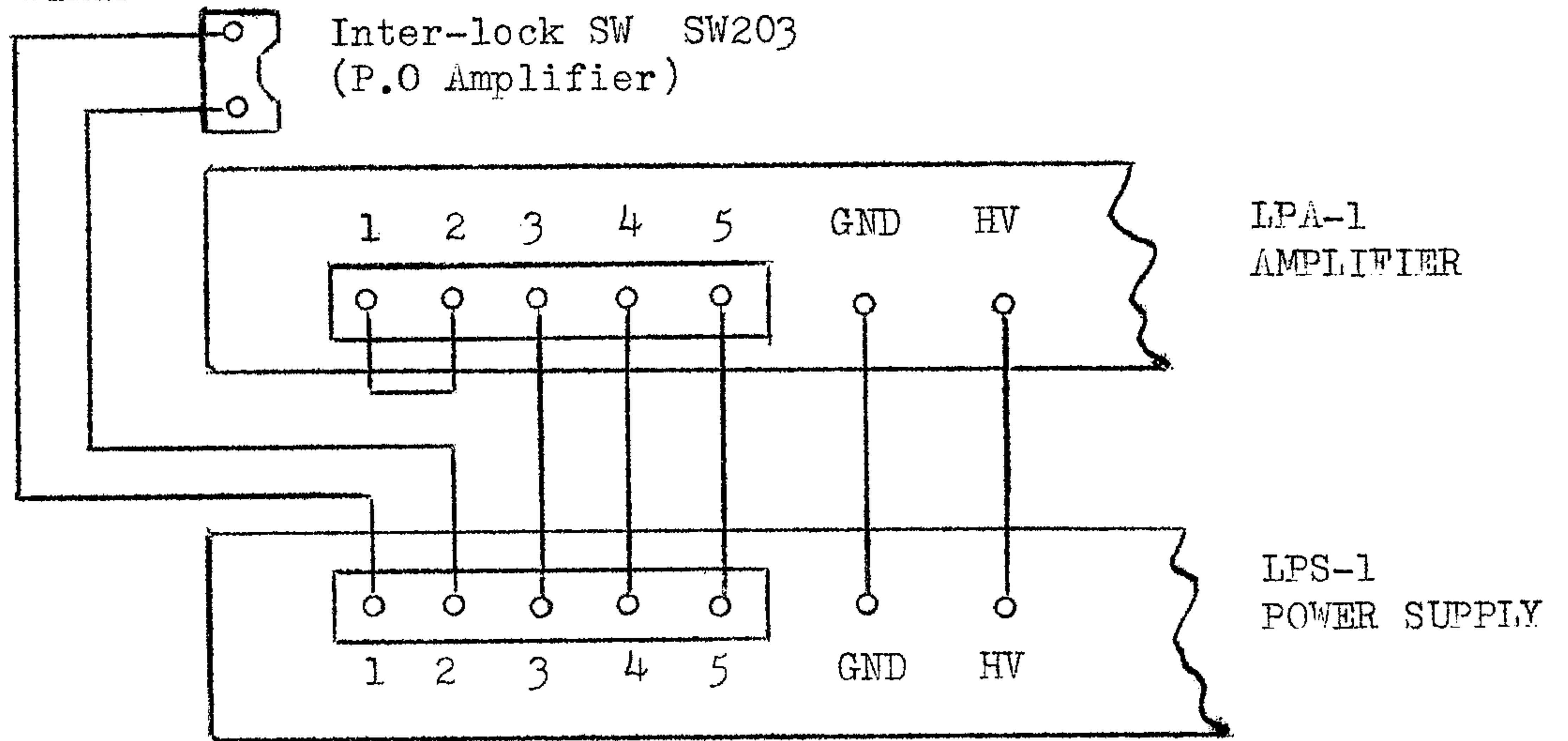

Revise inter-connections between LPA-1 & LPS-1 as shown in figures 5A, 5B & 5C, to that shown above

FIGURE 5

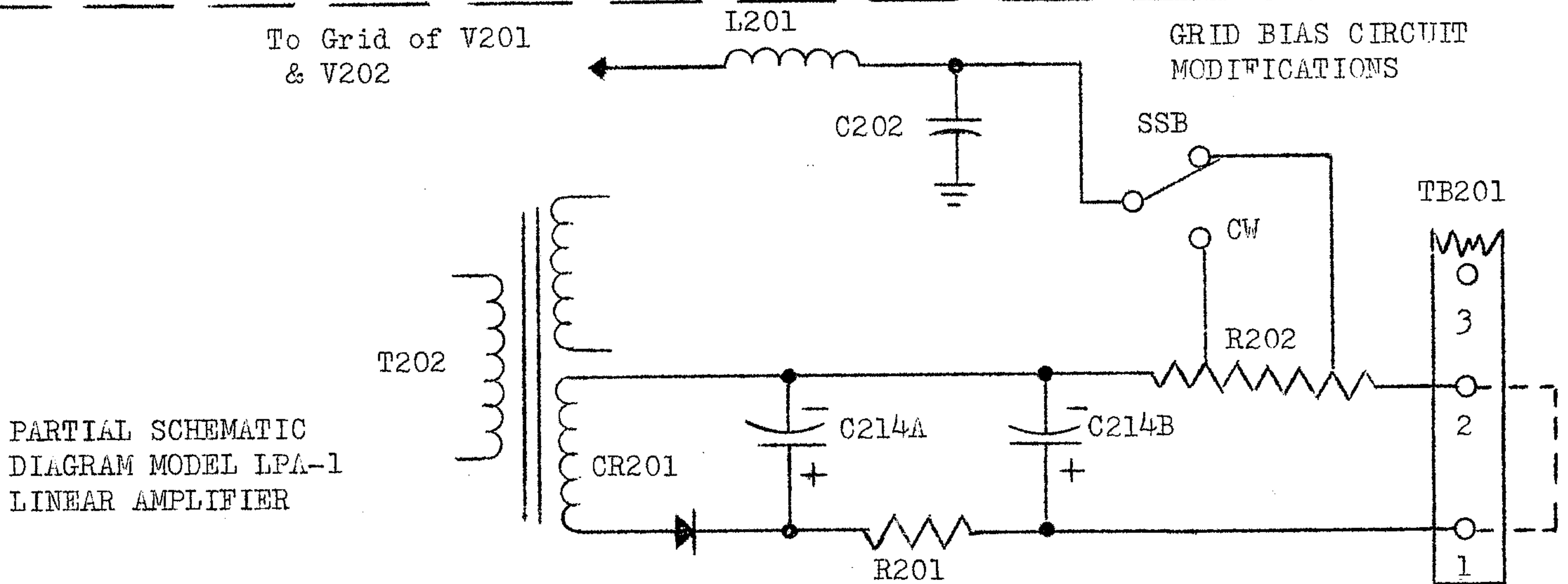

FIGURE 6

INTER-LOCK CIRCUIT  
MODIFICATION

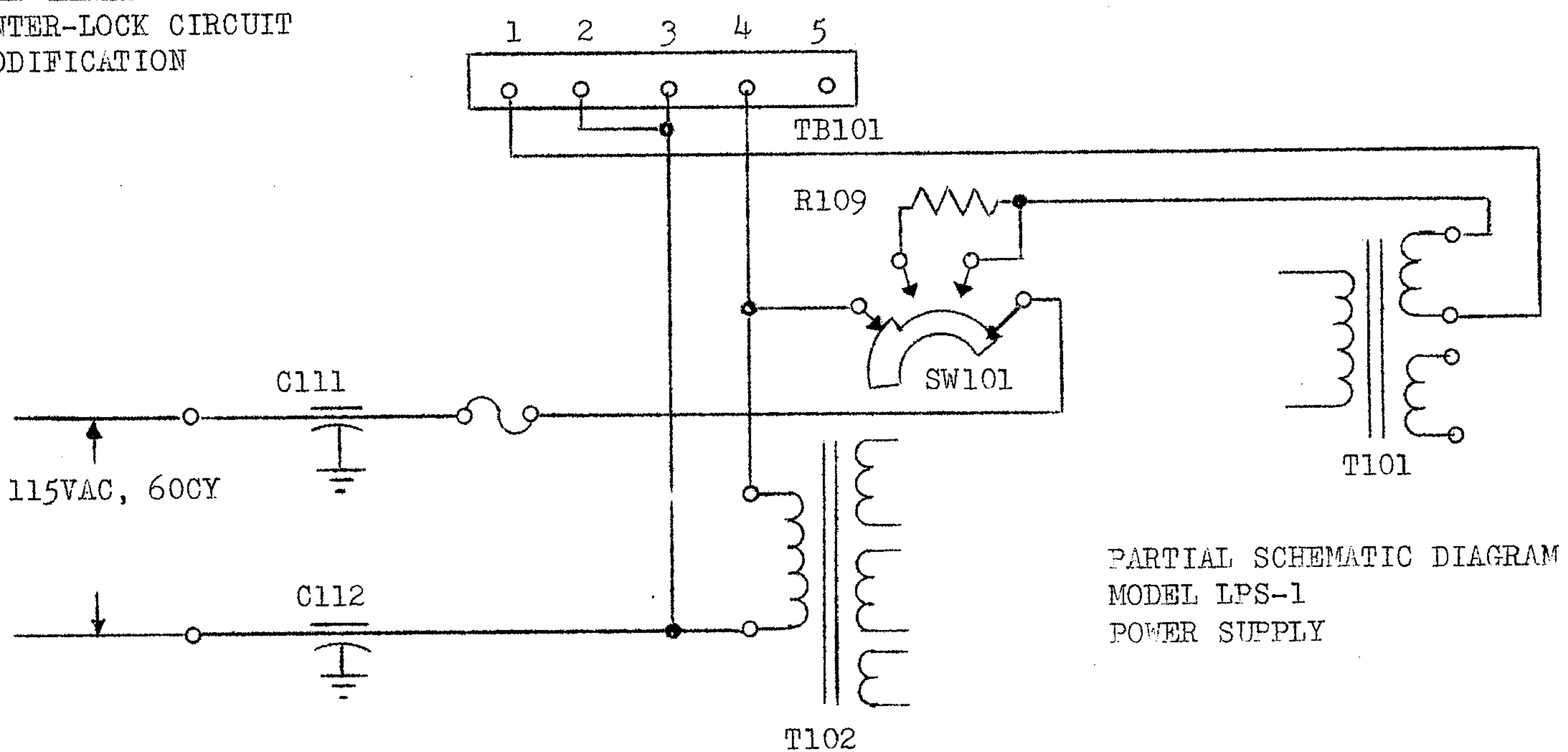

FIGURE 7



# **K4XL's** **BAMA**

This manual is provided **FREE OF CHARGE** from the “BoatAnchor Manual Archive” as a service to the Boatanchor community.

It was uploaded by someone who wanted to help you repair and maintain your equipment.

If you paid anyone other than BAMA for this manual, you paid someone who is making a profit from the free labor of others without asking their permission.

You may pass on copies of this manual to anyone who needs it. But do it without charge.

Thousands of files are available without charge from BAMA. Visit us at <http://bama.sbc.edu>